

3-6GHz 360Degree Analog Phase Shifter

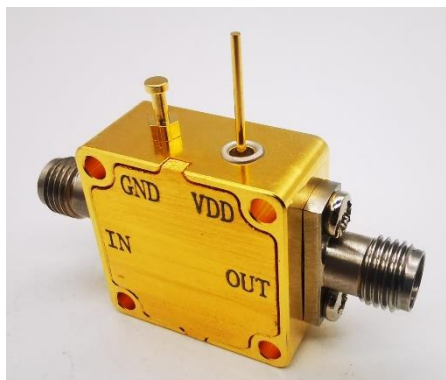

Description:

The AT-APS-0306-360 is an Analog Phase Shifter which is controlled via an analog control voltage from 0 to +14V.

It provides a continuous variable phase shift of 0 to 360 degrees from 3GHz to 6GHz with consistent insertion loss versus phase shift. The phase shift is monotonic with respect to control voltage.

Feature

- ✓ Wide Band Operation 3-6GHz
- ✓ 360 degree Phase Shift
- ✓ Low Insertion Loss
- ✓ Single Control Operation
- ✓ Customized Available

Application

- ✓ Point to Point Radios
- ✓ VSAT Radios
- ✓ Test Equipment
- ✓ Fiber Optic
- ✓ Military and Space

Electronical Specifications:

Parameter	Min	Typical	Max	Unit
Frequency Range		3-6		GHz
Phase Range		360		Degree
Insertion Loss		-5		dB
Return Loss		-12		dB
Control Voltage		0-14		V
Control Current		1		uA
Sensitivity		28		Deg/V
Response Time		250		ns
Temperature Sensitivity		0.1		Degree/C
Spec Temp		25C		





AT-APS-0306-360

Analog Phase Shifter, 3-6GHz, 360 degree

Mechanical Information

Item	Description
Input Port	SMA Female
Output Port	SMA Female
Case Material	Copper
Finish	Gold Plated
Package Sealing	Epoxy Sealed
Weight	80g
Size:	See outline

Absolute Maximum Ratings Table

Parameter	Value
Control Voltage	-0.5 to +18V
RF Input Power	+15dBm
Operating Temperature	-40 to +85C
Storage Temperature	-65 to +150C
ESD Sensitive(HBM)	Class 1B

Notes:

- ✓ Datasheet may be changed according to update of MMIC, Raw materials , process, and so on.
- ✓ This data is only for reference, not for guaranteed specifications.
- ✓ Please contact AT Microwave team to make sure you have the most current data.
- ✓ Always pay attention to the temperature of the case, heatsink and fan are required if case temperature exceeds over 50C.



移相VS频率 (Vt=0.5V~15V)

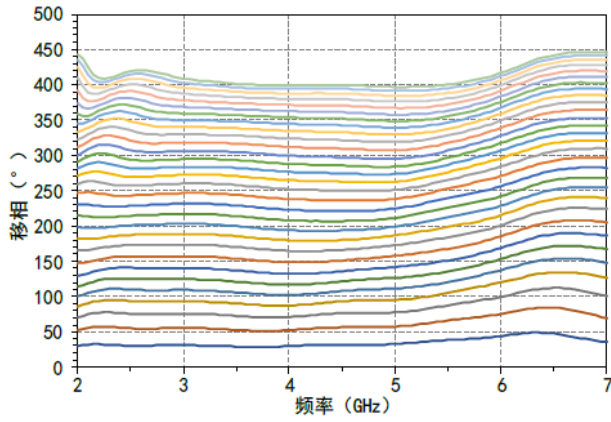

移相 VS Vt

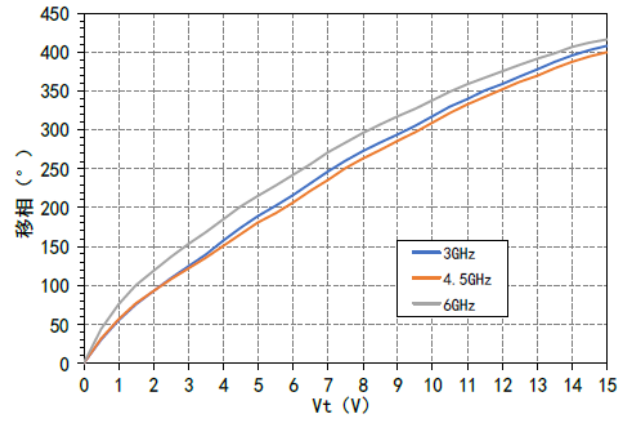

移相VS频率@Vt=14V

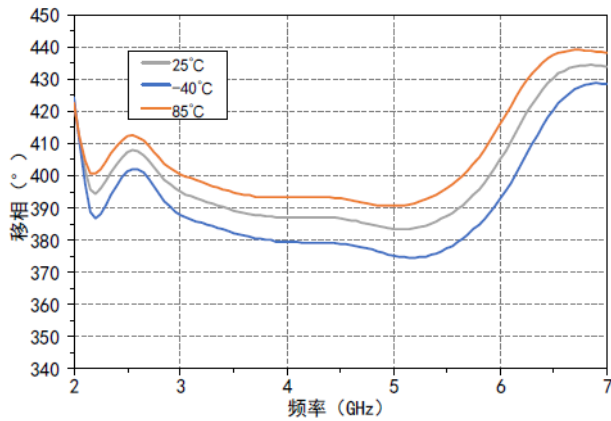

移相 VS Vt@4.5GHz

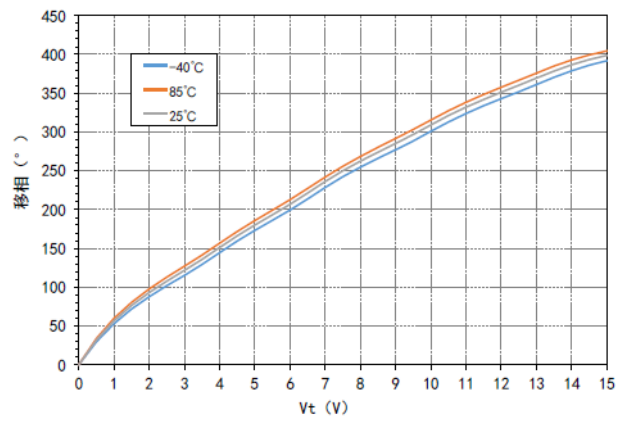

插入损耗VS Vt

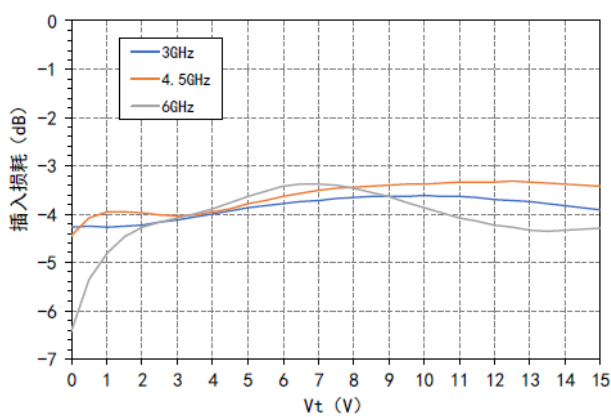

插入损耗 VS Pin@4.5GHz

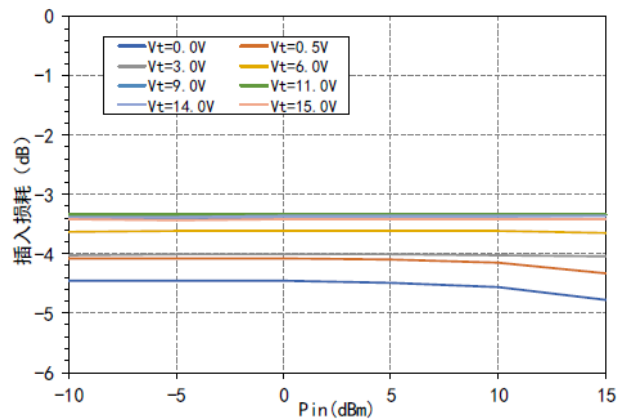

Dimension: (unit in mm)

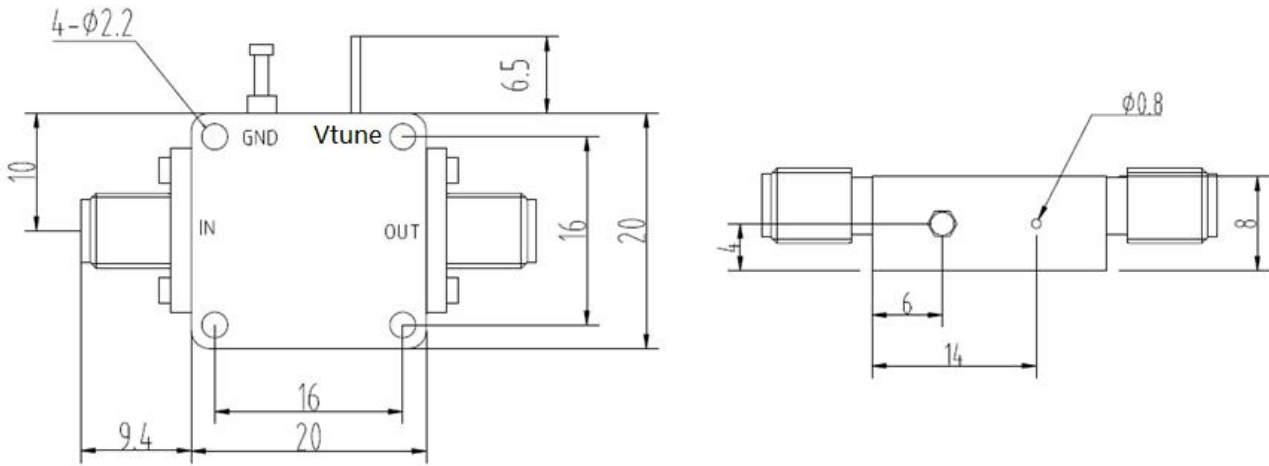

	<26.5GHz	<40GHz	<50GHz	<67GHz
Connector	SMA	2.92mm	2.4mm	1.85mm
Lenth of a	9.4mm	9.5mm	10.8mm	11.3mm

Note: Female Default. Contact with us for other types.

